

# ULA-30014

## Light Linear LA 7 RGBW Surface Floodlight



RGBW

66w LED 4026 Lumens  
 IP65 • Suitable For Wet Locations  
 IK10 • Impact Resistant (Vandal Resistant)  
 Weight 11.6 lbs

### Construction

**Aluminum**  
 Less than 0.1% copper content – Marine Grade 6060 extruded & LM6 Aluminum High Pressure die casting provides excellent mechanical strength, clean detailed product lines and excellent heat dissipation.

**Pre paint**  
 8 step decrease and phosphate process that includes deoxidizing and etching as well as a zinc and nickel phosphate process before product painting.

**Memory Retentive -Silicon Gasket**  
 Provided with special injection molded "fit for purpose" long life high temperature memory retentive silicon gaskets. Maintains the gaskets exact profile and seal over years of use and compression.

**Thermal management**  
 LM6 Aluminum is used for its excellent mechanical strength and thermal dissipation properties in low and high ambient temperatures. The superior thermal heat sink design by Ligman used in conjunction with the driver, controls thermals below critical temperature range to ensure maximum luminous flux output, as well as providing long LED service life and ensuring less than 10% lumen depreciation at 50,000 hours.

**Surge Suppression**  
 Standard 10kv surge suppressor provided with all fixtures.

**BVG Rating**  
 B5 - U5 - G5

**Finishing**  
 All Ligman products go through an extensive finishing process that includes fettling to improve paint adherence.

**Paint**  
 UV Stabilized 4.9Mil thick powder coat paint and baked at 200 Deg C. This process ensures that Ligman products can withstand harsh environments. Rated for use in natatoriums.

**Inspired by Nature Finishes**  
 The Inspired by nature Finishing is a unique system of decorative powder coating. Our metal decoration process can easily transform the appearance of metal or aluminum product into a wood grain finish.

This patented technology enables the simulation of wood grain, and even marble or granite finish through the use of decorative powder coating.

The wood grain finish is so realistic that it's almost undistinguishable from real wood, even from a close visual inspection. The system of coating permeates the entire thickness of the coat and as a result, the coating cannot be removed by normal rubbing, chipping, or scratching.

**The Coating Process**  
 After pre-treatment the prepared parts are powder coated with a specially formulated polyurethane powder. This powder provides protection against wear, abrasion, impact and corrosion and acts as the relief base color for the finalized metal decoration.

The component is then wrapped with a sheet of non-porous film with the selected decoration pattern printed on it using special high temperature inks.

This printed film transfer is vacuum-sealed to the surface for a complete thermo print and then transferred into a customized oven. The oven transforms the ink into different forms within the paint layer before it becomes solid. Finally, the film is removed, and a vivid timber look on aluminum remains.

Wood grain coating can create beautiful wood-looking products of any sort. There are over 300 combinations of designs currently in use. Wood grains can be made with different colors, designs, etc.

Our powder coatings are certified for indoor and outdoor applications and are backed by a comprehensive warranty. These coatings rise to the highest conceivable standard of performance excellence and design innovation.

- Added Benefits**
- Resistance to salt-acid room, accelerated aging
  - Boiling water, lime and condensed water resistant
  - Anti-Graffiti, Anti-Slip, Anti-Microbial, Anti-Scratch
  - Super durable (UV resistant)
  - TGIC free (non-toxic)

**Hardware**  
 Provided Hardware is Marine grade 316 Stainless steel.

**Anti Seize Screw Holes**  
 Tapped holes are infused with a special anti seize compound designed to prevent seizure of threaded connections, due to electrolysis from heat, corrosive atmospheres and moisture.

**Crystal Clear Low Iron Glass Lens**  
 Provided with tempered, impact resistant crystal clear low iron glass ensuring no green glass tinge.

**Optics & LED**  
 Precise optic design provides exceptional light control and precise distribution of light.  
 LED CRI > 80

**Lumen - Maintenance Life**

### Efficient quality linear fixture portfolio. Coordinated grazing-floodlight range with multiple optics and component options.

Light Linear LA 6 wall wash or wall grazing floodlight family is designed as a perfect solution for color changing applications, as well as static color for architectural structures, wall grazing, column lighting and linear floodlighting. This high performance luminaire, with superior optic design is suitable for many applications including commercial, historic or modern architectural interiors and exteriors.

Two different lengths, 2' and 4' allow the luminaire installation to be tailored exactly to the architectural structure. Luminaires can be installed end to end, without any gaps or shadows in the lighting design. An integral driver is provided, however this product can be supplied with remote driver applications, please contact the factory for more details.

Light Linear LA is available in 2700K, 3000K, 3500K and 4000K, as well as RGBW. This linear line is also provided in Inground, Recessed wall and Pendant, see Ligman website

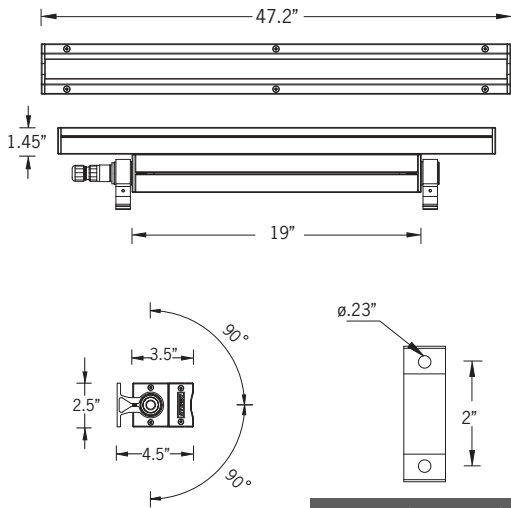

Mounting Detail

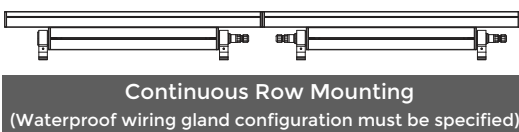

Continuous Row Mounting  
 (Waterproof wiring gland configuration must be specified)

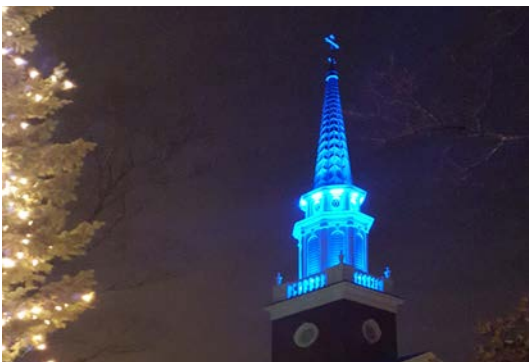

### Additional Options (Consult Factory For Pricing)

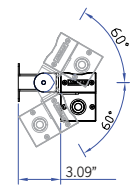

ADJ3 - 3" Extended Arm

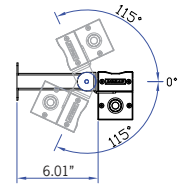

ADJ6 - 6" Extended Arm

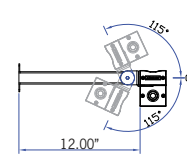

ADJ12 - 12" Extended Arm

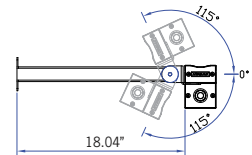

ADJ18 - 18" Extended Arm

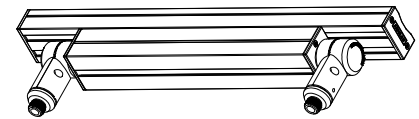

TKM - Threaded Knuckle Mount



A64691 TPC Touch Screen and Controller DMX 2 [Pharos]    A68391 STICK-DE3 [Nicolaudie]    A64491 TPC Touch Screen and Controller DMX [Pharos]    A64591 POE Connect [Pharos]



A66991 LPCX Lighting Playback Controller X [Pharos]    A64791 RDM DMX Splitter [Pharos]    A65191 TPC Touch Panel Station [Pharos]    A65391 EDN Ethernet Data Node [Pharos]



A64991 CLOUD [Pharos]

# ULA-30014

Light Linear LA 7 RGBW Surface Floodlight



|                |  |             |  |
|----------------|--|-------------|--|
| <b>PROJECT</b> |  | <b>DATE</b> |  |
|----------------|--|-------------|--|

|                 |  |             |  |             |  |
|-----------------|--|-------------|--|-------------|--|
| <b>QUANTITY</b> |  | <b>TYPE</b> |  | <b>NOTE</b> |  |
|-----------------|--|-------------|--|-------------|--|

ORDERING EXAMPLE || ULA - 30014 - 66w LED - N - RGBWW30 - 02 - 120/277v

|                        |  |  |   |                             |  |
|------------------------|--|--|---|-----------------------------|--|
| <b>ULA-30014</b>       |  |  |   |                             |  |
| <b>LAMP</b>            | <b>BEAM</b>  | <b>RGBW COLOR</b>  | <b>FINISH COLOR</b>   | <b>VOLTAGE</b>              |  |
| 66w LED<br>4026 Lumens | VN - Very Narrow 10°<br>N - Narrow 13°<br>M - Medium 25°<br>W - Wide 43°<br>E - Elliptical 28° x 35° | RGBW30 - Warm White 3200K<br>RGBW40 - Neutral White 4000K<br>RGBW65 - Cool White 6850K | 01 - BLACK RAL 9011<br>02 - DARK GREY RAL 7043<br>03 - WHITE RAL 9003<br>04 - METALLIC SILVER RAL 9006<br>05 - MATTE SILVER RAL 9006<br>06 - LIGMAN BRONZE<br>07 - CUSTOM RAL | 120/277v<br>Other - Specify |  |

|  |  |  |  |
|--|--|--|--|
|  |  |  |  |
|--|--|--|--|

## ADDITIONAL OPTIONS

- |                                 |                               |
|---------------------------------|-------------------------------|
| F - Frosted Lens                | ADJ3 - 3" Extended Arm        |
| DIM - 0-10v Dimming             | ADJ6 - 6" Extended Arm        |
| NAT - Natatorium Rated          | ADJ12 - 12" Extended Arm      |
| TKM - Threaded Knuckle Mount    | ADJ18 - 18" Extended Arm      |
| A64791 - RDM DMX Splitter       | A68391 - STICK-DE3            |
| A65191 - TPC Touch Panel        | A64491 - TPC + DMX Controller |
| A65391 - EDN Ethernet Data Node | A64591 - POE Connect          |
| A66991 - LPCX Lighting Playback | A64691 - TPC + DMX 2          |
| A64991 - CLOUD                  |                               |

**INSPIRED BY NATURE FINISHES**

|                             |  |
|-----------------------------|--|
| SW01 - OAK FINISH           |  |
| SW02 - WALNUT FINISH        |  |
| SW03- PINE FINISH           |  |
| DF - DOUGLAS FIR FINISH     |  |
| CW - CHERRY WOOD FINISH     |  |
| NW - NATIONAL WALNUT FINISH |  |
| SU01 - CONCRETE FINISH      |  |
| SU02 - SOFTSCAPE FINISH     |  |
| SU03 - STONE FINISH         |  |
| SU04 - CORTEN FINISH        |  |

THERE IS AN ADDITIONAL COST FOR THESE FINISHES

## More Custom Finishes Available Upon Request

Consult factory for pricing and lead times

|        |          |        |            |
|--------|----------|--------|------------|
|        |          |        |            |
| Oak    | Cherry   | Beech  | Carbon     |
|        |          |        |            |
| Walnut | Chestnut | Bamboo | Galvanized |
|        |          |        |            |
| Pine   | Mahogany | Birch  | Steel      |



## CABLE GLAND

Ligman supplies this luminaire with 3ft of cable to connect to power and where specified controls. [Additional cable lengths can be provided and should be specified]

It is important to identify what configuration is required for the installation [One Gland or Two Gland Units]

A waterproof cable connector can be provided and should be ordered as an optional extra

1GL

Specify Quantity



1GL - One Gland for Single Fixture and End Installation

CNCT

Specify Quantity



Optional  
CNCT - Waterproof Cable Connector

2GL

Specify Quantity

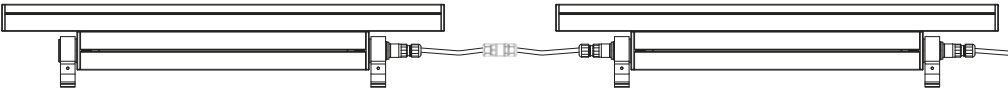

2GL - Two Gland for Continuous Row Mounting

## EXTRA CABLE LENGTH

Specify Cable Length in Feet

Custom lengths can be provided  
as an option [contact factory for pricing]



## TPC Touchscreen & EXT Controller DMX & DALI 1 Universe

The TPC (Touch Panel Controller) is an elegant touch screen lighting controller with a customisable, 4.3" capacitive touch panel, 512 channels of eDMX output and vast interfacing potential, all over a single Power-over-Ethernet (PoE) network connection.

The EXT is an extension for the Pharos TPC and together they form a standalone, mainspowered lighting controller with versatile output and show control options. The EXT provides local DMX and DALI output for the TPC, as well as power and other hardware interfaces.



**A64491**



**A64691**

## TPC Touchscreen & LPC Controller DMX 2 Universe

The LPC (Lighting Playback Controller) is an all-in-one control solution for themed entertainment and LED lighting installations. It features individually controllable and independently running timelines and scenes. Supported fixtures include LEDs in any configuration (RGB, RGBW, tunable white), moving heads, yokes or scanners and fountain jets. Output includes DMX512, Art-Net, DALI & RDM.

## POE Connect

The POE (Power-over-Ethernet Switch) provides a simple power and networking solution for four Power-over-Ethernet devices with two separate Ethernet uplink ports. It is perfect for connecting power and data between Pharos Controllers and Pharos Remote Devices.



**A64591**



## RDM DMX Splitters

The RDM (Remote Device Management) is a 4 port DMX512 Splitter compatible with the RDM standard to provide DMX output to luminaires and other devices. DMX splitters are an essential requirement for most control systems, allowing multiple separate cable runs from a single DMX output and ensuring electrical isolation.

**A64791**

## TPS Touch Panel Station

The Pharos TPS (Touch Panel Station) is an elegant interface with a customizable, 4.3" capacitive touch screen, that works with any Pharos Controller



**A65191**



**A64991**

## CLOUD

The CLOUD makes it easy to achieve remote control and management which is truly remote and totally secure.

Once connected, users can adjust hardware settings remotely, schedule tasks, control multiple projects, view system status, set remote user permissions, and more; through a standard internet connection without any additional hardware.

## LPCX Lighting Playback Controller X

The Pharos LPC X (Lighting Playback Controller X) offers an extreme level of power and integration, making it an ideal solution for landmark lighting installations with significant channel counts. It integrates with the full range of Pharos products and offers an optional real-time video input



**A66991**



**A65391**

## EDN Ethernet Data Node

The Pharos EDN (Ethernet Data Node) is a convenient and scalable solution, providing cost-effective Ethernet distributed DMX ports for large control projects. The EDN is an easily configurable networking node that is specifically designed to add physical DMX ports to Pharos Controllers and integrates natively with the full Pharos range.

Extremely compact, it packs up to 20 DMX512 output ports into a 1U 19" form factor. For higher port count installations, nodes can be daisy-chained to provide as many physical DMX ports as you need.

EDNs are discoverable through Pharos Designer software and associated to a Controller to be seamlessly configured as part of your patch. Ports can be flexibly assigned to any controller in your project providing an elegant data distribution solution over an Ethernet network with minimal setup required.

## DMX/RDM Decoder - 24 VDC - Remote IP65 Box

- Control mode: RGBW / RGB / Custom / Dimming
- Compatible with DMX protocol (ANSI E1.11) and RDM function (ANSI E1.20)
- Output power: 33 W x 4 Channels (132 W max)
- Input voltage: 12-36 VDC
- Output voltage: 7.5-33 VDC

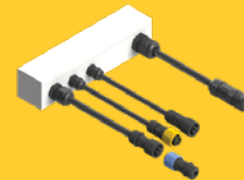

**A67091**



## SLESA-U9

The Nicolaudie SLESA-U9 is a standalone USB based DMX256 lighting controller with 20 scenes and 1 zone. This simple and reliable control allows dynamic lighting scenes to be programmed quickly and easily through the ESA2 software for uninterrupted independent operation.



**A60491**



## SLESA-U11

The Nicolaudie SLESA-U11 is a standalone engine (NSA) offering incredible power based DMX2048+ lighting controller with 99 scenes 5 zones, extended triggers and 16-bit channels management. Intuitive backlit keyboard with 10 presets and zone selection. Lighting scenes can be programmed quickly and easily through ESAPRO2 software via USB or Ethernet connection and mobile applications.

**A66891**

## DMX Splitter & Amplifier in IP Box

Digital signal distributor is used with DMX512 digital lighting control signal for amplification and 2 channel distribution output. Each input/output interface adopts high voltage isolation technology, applied to DMX512 signal via remote transmission attenuation after the plastic amplification processing. Complete electrical isolation is used between the input interface and the distribution between output interface.



**A63991**



**A67291**

## DINA-DR MICRO DMX Lighting Controller & Power Adapter

The DINA-DR MICRO is the perfect standalone lighting controller for simple DMX installations. It offers an affordable and programmable solution to replace automatic controllers.

Delivered with a DIN rail adapter, the DINA-DR MICRO can be mounted in an electrical cabinet and affords significant ease of installation.

Create your static or dynamic lighting scenes with ESA Pro 2 software and upload them to the DINA-DR MICRO through its USB connection. Specifications: 10 scenes, 1 zone, 60 channels.

## STICK-DE3

The feature rich lighting controller has been designed to provide a control solution for the most demanding of projects, whilst maintaining an easy to use panel of touch sensitive buttons. The controller integrates a graphical color screen allowing scene photos to be displayed. Easily view the selected zone, scene name and design without the need to navigate through complex menus.

Change the speed, color and dimmer using the circular palette. The lighting levels, color and effects can be programmed from a PC, Mac, Android, iPad or iPhone using the included software



**A68391**

# Light Linear LA Product Family



Light Linear LA 1

- ULA-60001-28w-2847lm
- ULA-60002-57w-5703lm
- ULA-60003-28w-2566lm [Asymmetric]
- ULA-60004-57w-5140lm [Asymmetric]



Light Linear LA 2

- ULA-60013-33w-1916lm
- ULA-60014-66w-3839lm



Light Linear LA 3

- ULA-95001-28w-2847lm
- ULA-95002-55w-5703lm



Light Linear LA 4

- ULA-95021-28w-2847lm
- ULA-95022-55w-5703lm



Light Linear LA 6

- ULA-30001-28w-2847lm
- ULA-30002-55w-5703lm



Light Linear LA 7

- ULA-30013-33w-2018lm
- ULA-30014-66w-4043lm



Light Linear LA 8

- ULA-30021-28w-2847lm
- ULA-30022-55w-5703lm



Light Linear LA 9

- ULA-40001-28w-2847lm
- ULA-40002-57w-5703lm



Light Linear LA 10

- ULA-40013-33w-3948lm
- ULA-40014-66w-4043lm